

auto electrical parts

Technical Information Sheet

Part No. 0-668-34

LED Interior Lamp. 10-30V. 94 White LED's.
1120Lumens. Polycarbonate housing with aluminium
base.
EMC Approved.

Additional Information:

Red wire +ve switched supply
Black wire -ve ground



Technical Drawing (not to scale)

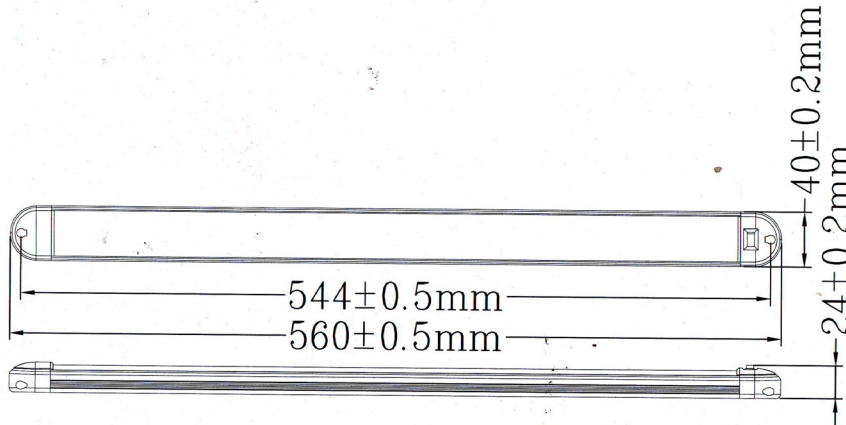

Specification

Type	LED Interior Lamp
Voltage	10-30V
Current	0.39A @ 13.5V
No. of LED's	94 LED's
LED Power (Total)	5.26W
Lumens	1120Lm
Housing	Polycarbonate Housing / Aluminium Base
Operation Temperature	-20°C to 60°C
Protection	N/A
Weight	0.261KG
Dimensions	560 x 40 x 24mm
Compliance	EMC

The information contained in this document is correct to the best of our knowledge at the time of printing. However, specifications may change at any time without notice.